

**TTi<sup>®</sup>**

# Colorimeter Series Quick-Start Guide



Taylor Water Technologies LLC  
800-TEST KIT (837-8548)  
[www.TaylorTechnologies.com](http://www.TaylorTechnologies.com)





# TABLE OF CONTENTS

PRECAUTIONS .....	2
COMPONENTS AND OPTIONAL ACCESSORIES .....	3
GUIDE TO PARTS, OPERATING CONTROLS, AND MAIN MENU .....	4
BATTERY INSTALLATION OR CONNECTION TO A POWER SUPPLY .....	7
INITIAL START-UP AND OPERATION .....	8
<i>PC APP</i> .....	14
<i>USER'S MANUAL</i> .....	15
WARRANTY INFORMATION .....	16
MAINTENANCE .....	17
IF YOU NEED TECHNICAL ASSISTANCE .....	18
INSTRUMENT SPECIFICATIONS .....	19
SYMBOL EXPLANATION .....	20
INSTRUMENT CERTIFICATION AND INFORMATION TO THE USER .....	21



This *Quick-Start Guide* provides a brief summary of the *TTi® Colorimeter Series User's Manual*. It is designed to walk you through a typical test procedure. The *User's Manual* and actual test instruction(s) should be read in their entirety before using this instrument.

## **Description and Use**

The TTi® Colorimeter is a portable, multiwavelength, microprocessor-controlled, menu-driven, direct-readout instrument that uses LED light sources and has data-logging capabilities. It is suitable for performing multiparameter water analyses on-site or in the laboratory.

## PRECAUTIONS

For operator safety and to avoid damage to the instrument, the following precautions should be observed:

- **Chemical safety**

Reagents for use with the instrument can be hazardous. Read and observe all information printed on reagent labels and corresponding Safety Data Sheets (SDSs) prior to use. To view or print reagent SDSs, visit the Resource Center of our website, [www.TaylorTechnologies.com](http://www.TaylorTechnologies.com).

- **Keep reagents out of reach of children.**
- **Use only Taylor reagents for preprogrammed tests.**

- **Operational requirements**

During operation, the instrument should be placed on a stable surface that is reasonably level, or be held in a horizontal position if used as a handheld instrument.

- **Environmental conditions**

Do not use or store the instrument in environments of extreme temperature or humidity.

Do not immerse the instrument in water.

Do not leave the instrument exposed to direct sunlight for a prolonged period.

## COMPONENTS AND OPTIONAL ACCESSORIES

This kit contains the following components:

### Quantity Part Number

1	M-XXXX	TTi® Colorimeter (model number on instrument faceplate)
1	5543	<i>Quick-Start Guide</i>
4	6105	AA Alkaline Battery
1	6535	AC Power Adapter
1	6551	Dilution Vial, 50 mL w/ cap
1	6552	USB Cable
4	6649	Foam Brush
1	6672	Cleaning Cloth, Colorimeter Vials
2	9601	Sample Cell, 25 mm w/ cap
2	9602	Sample Cell, 15 mm w/ cap

### Optional accessories:

K-8000	TTi® Colorimeter Series Accuracy Check Kit
7203	Replacement Foam Insert, (for 7146)
9502	Hard Carrying Case, gray (20"w x 15.625"d x 5.5"h)
9504	Hard Carrying Case, blue (20"w x 15.625"d x 5.5"h)
9506	Hard Carrying Case, gray (10.75"w x 9"d x 7"h)

Note: All components and optional accessories (excluding batteries), as well as reagent packs, are available directly from Taylor Water Technologies or authorized distributors. To order from Taylor, call toll-free 800-TEST KIT (837-8548).

# GUIDE TO PARTS, OPERATING CONTROLS, AND MAIN MENU

Review the following illustrations to become familiar with parts, operating controls, and Main Menu options.

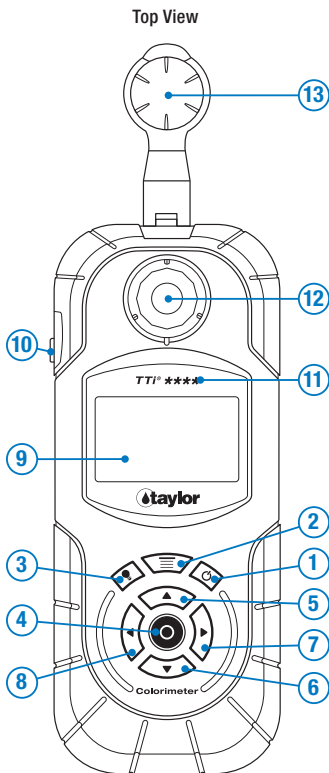

## Top View

1. Power Button
2. Main Menu Button
3. Backlight Button
4. Enter Button, to enter the highlighted function
5. Scroll Up Arrow
6. Scroll Down Arrow
7. Scroll Right Arrow
8. Scroll Left Arrow
9. Liquid Crystal Display
10. USB Port Cover
11. Model Number
12. Sample Cell Compartment (shown open)
13. Sample Cell Compartment Cover

## Bottom View



## Bottom View

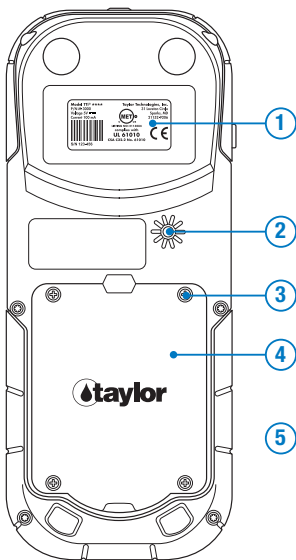

1. Product Label, shows model, part, and serial numbers
2. Timer Buzzer Opening
3. Battery Compartment Door Screw, total of 4
4. Battery Compartment Door
5. Battery Compartment (shown open)

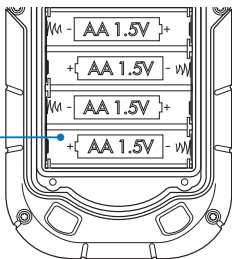

## Side View

6. USB Port (shown open)
7. USB Port Cover

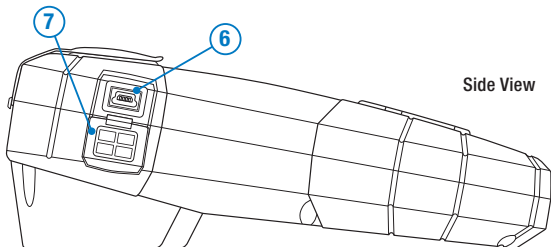

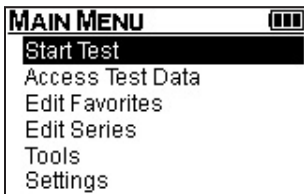

1. **Start Test** – Select to access FAVORITES, RECENT TESTS, or ALL TESTS menus.
2. **Access Test Data** – Select to recall or erase test data.
3. **Edit Favorites** – Select to create or edit (add, remove, sort) Favorites menu.
4. **Edit Series** – Select to create or edit (add, remove, sort) Series tests.
5. **Tools** – Select to transfer data or access the User Timer.
6. **Settings** – Select to access About (displays Firmware, Test File, and Bootloader Versions), or to modify instrument settings (Format Date, Set Date, Format Time, Set Time, Device Timeout, Backlight Timeout, Backlight Level, Adjust Contrast, Language, and Factory Restore).

## BATTERY INSTALLATION OR CONNECTION TO A POWER SUPPLY

Select one of the following options to supply power to the instrument:

- A. Insert 4 AA alkaline (supplied) or lithium batteries by matching the + and – ends on the batteries to the markings inside the battery compartment.
- B. Connect the AC power adapter (supplied) to the USB port on the instrument; then plug the AC power adapter into a 120V AC wall outlet. The adapter is intended for indoor use.
- C. Connect the USB cable (supplied) to the USB port on the instrument; then connect the USB cable to the corresponding USB port on a PC or laptop.

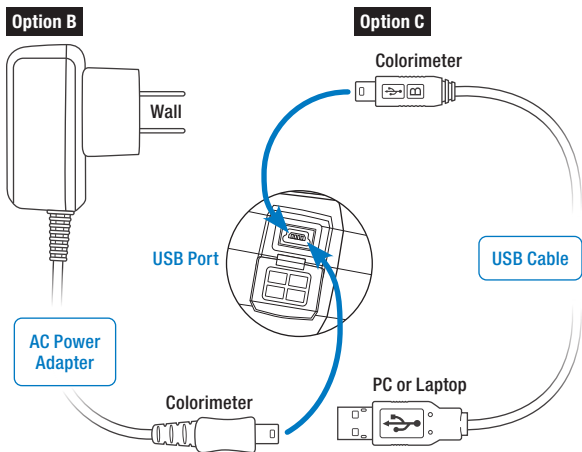

## INITIAL START-UP AND OPERATION

The following Quick-Start Test example will walk you through initial start-up, show you how to perform a typical test with a timing step, and how to automatically read the sample using the AUTO function. Test reagents are not required for this example.





### STEP 1

#### Turn on the Colorimeter

Press POWER button  for approximately 0.5 seconds.



### STEP 2\*

**Set Date** using , , , ; then press ENTER .

\*Step 2 required for **initial start-up only**

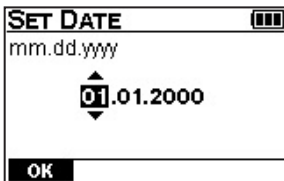

### STEP 3\*

**Set Time** using , , , ; then press ENTER .

\*Step 3 required for **initial start-up only**

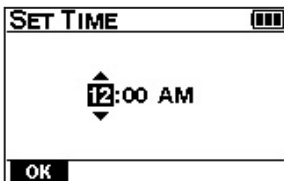

## STEP 4\*

Select **Start Test** from the MAIN MENU using ▲▼; then press ENTER ○.

\*Step 4 required for **initial start-up only**. After initial start-up has been performed, steps 2–4 will be skipped after turning on the instrument.

MAIN MENU	
Start Test	
Access Test Data	
Edit Favorites	
Edit Series	
Tools	
Settings	

## STEP 5

Select **Quick-Start Test 500** from ALL TESTS menu using ▲▼; then press ENTER ○.

ALL TESTS	
▲ Phosphate	70
Phosphonate	20
Polymer	20
Polymer	500
Quick-Start Test	500
▼ Silica	4

### Test Menu

The user can select a test from one of three test menus using ◀▶:

**ALL TESTS** – Contains all tests programmed into the Colorimeter

**RECENT TESTS** – Contains the 10 most recent tests performed

**FAVORITES** – Contains only tests selected by user

## STEP 6

Confirm test name and range and sample cell size used in the test procedure.

Select a chemical form ( $\text{CaCO}_3$ , Ca, or Mg) for expression of test results using ▲▼.

Test Name and Range (or Range Upper Limit)

Chemical Form

Optional chemical forms are available for most tests. The Range (or Range Upper Limit) will change to correlate with the selected chemical form.

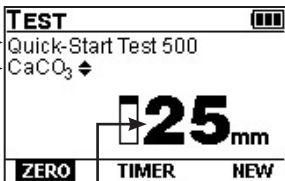

Sample Cell Size

## STEP 7

### Prepare Blank

Typical procedure for preparing a blank:

- Fill 25 mm sample cell to 10 mL mark with sample (**use tap or deionized water for this example**); then cap.
- Insert sample cell into sample cell compartment. Align marks.

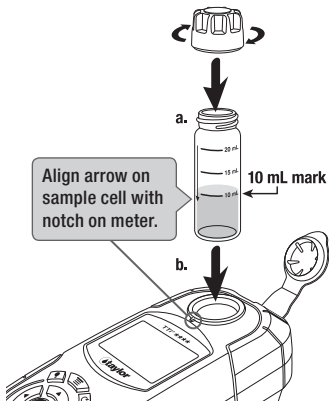

## STEP 8

### Zero the Colorimeter

Select ZERO using ◀▶; then press ENTER ○.

Zero will be displayed.

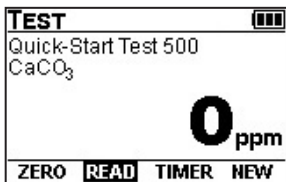

## STEP 9

### Prepare Sample

Typical procedure for preparing a sample:

- Remove sample cell from sample cell compartment; then remove cap.
- Add test reagents (not required for this example). Replace cap and mix thoroughly.
- Insert sample cell into sample cell compartment. Align marks.

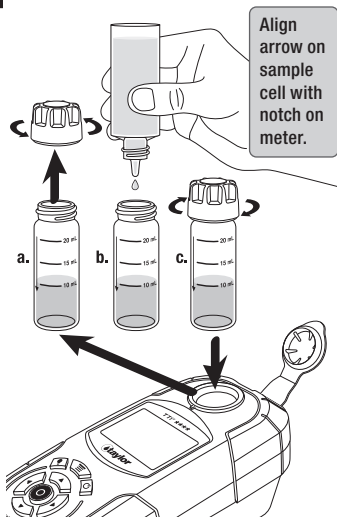

## STEP 10

### Access Timer

Select **TIMER** using  $\blacktriangleleft\blacktriangleright$ ;  
then press **ENTER**  $\odot$ .

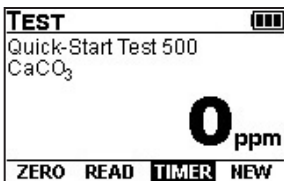

## STEP 11

### Start TIMER and AUTO Option

Select **START** using  $\blacktriangleleft\blacktriangleright$ ;  
then press **ENTER**  $\odot$ .  
(A 30-second (00:30) countdown will begin.)  
Immediately select **AUTO**  
using  $\blacktriangleleft\blacktriangleright$ ; then press  
**ENTER**  $\odot$ .

**Timer Icon** starts flashing

Display returns to Test  
screen and Timer Icon  
continues flashing

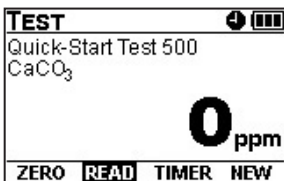
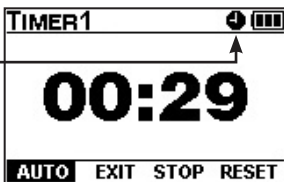
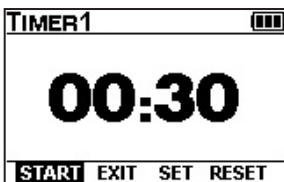



## STEP 12

### Read the Sample

When the timer beeps, the instrument will automatically read the sample and the result will be displayed.

### Result

Result will be displayed in terms of selected chemical form.

**Timer Icon** remains visible  
Result expressed as  $\text{CaCO}_3$

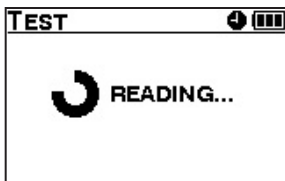

Result expressed as **Ca**

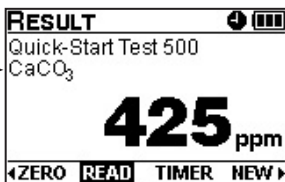

Result expressed as **Mg**

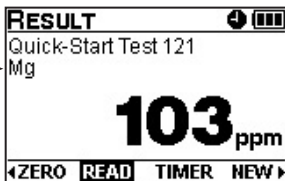
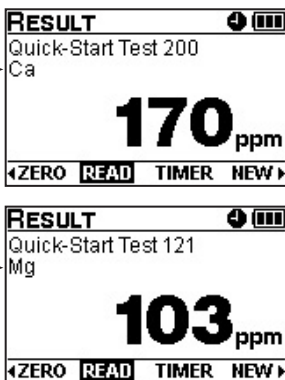

## PC APP

To use your TTI® Colorimeter to the fullest extent possible, installing a special free software application on your PC is necessary.

The *TTi® Colorimeter Series PC App* is required to perform the following functions:

- Transfer test results from your meter to the customer database you maintain on your PC or laptop
- Create proprietary (i.e., user-developed) test files
- Keep the meter's operating software (i.e., firmware) up to date
- Receive notification of newly available test files, as well as any improvements to existing test files, so you can add them to your meter's capabilities

Go to <https://taylortechnologies.com/en/content/colorimeter-support> to obtain the latest edition of the *TTi® Colorimeter Series User's Manual* and access helpful links for further information and assistance. Be prepared to enter registration information consisting of:

- Colorimeter serial number (S/N) – found on the product label on the bottom of the meter
- Owner's (contact's) name

- Business name
- Contact's telephone number
- Contact's e-mail – where you can be notified of important news about your meter model

Upon completing the registration process you will be able to download the *PC App* to your computer.

## ***USER'S MANUAL***

Using the PC App installed on your computer (described above), obtain the *TTi® Colorimeter Series User's Manual* and read it in its entirety. It contains detailed information about instrument operation, features, test alerts and error codes, maintenance and repair, optional accessories, and much more.

## WARRANTY INFORMATION

Instruments in the TTI® Colorimeter Series found to be defective within five years from the date of purchase will be repaired or replaced at the option of Taylor Water Technologies for any registered owner. The warranty does not cover batteries, nor damage caused by operator negligence or use of test chemistries not manufactured by Taylor or unauthorized repair work, nor the transportation and insurance costs to return the unit to our factory. The cost of all parts, labor, and return shipping to the owner will be borne by Taylor Water Technologies within the warranty period. All other warranties, express or implied, including warranties of merchantability and fitness for a particular purpose, are excluded.

- Record the Colorimeter's serial number here (S/N found on the product label on the bottom of the meter): \_\_\_\_\_
- Date of purchase: \_\_\_\_\_

We recommend attaching your proof of purchase to this *Quick-Start Guide* and filing it securely in case of a future claim. You may call 800-TEST KIT (837-8548) to request service under this warranty.

## MAINTENANCE

Do not use chemicals, solvents, or abrasives to clean or dry any part of the instrument. Clean and dry the enclosure, display, sample cell compartment, and sample cells after use or when needed as follows:

- **Enclosure** – Use a soft, nonabrasive cloth and water or mild detergent.
- **Display** – Be careful not to scratch the display. Use a soft, nonabrasive cloth or lens tissue and water or mild detergent.
- **Sample Cell Compartment** – Be careful not to scratch the sample cell compartment. Use the foam brush (supplied), a soft, nonabrasive cloth or lens tissue and water or mild detergent.
- **Sample Cells** – Be careful not to scratch the sample cells. Use the foam brush (supplied) or a soft, nonabrasive cloth and water or mild detergent. Rinse thoroughly with deionized or distilled water.

## IF YOU NEED TECHNICAL ASSISTANCE

### Contact:

Taylor Water Technologies LLC  
31 Loveton Circle  
Sparks, Maryland 21152-9206  
USA

General assistance for TTI® Colorimeter owners and help specifically related to the *PC App* is available Monday through Friday from 8:00 a.m. – 5:00 p.m. Eastern Time, except major holidays, from Taylor Water Technologies' tech support. Call **877-TEST KIT (837-8548)**. Online guidance may be found at [www.TaylorSoftwareSupport.com](http://www.TaylorSoftwareSupport.com).

## INSTRUMENT SPECIFICATIONS







Performance	
Photometric Range	0–2 ABS
Photometric Accuracy	$\pm 0.005$ ABS @ 1.0 ABS nominal
Photometric Linearity	$\pm 0.002$ ABS (0–1 ABS)
Repeatability	$\pm 0.005$ ABS (0–1 ABS)
Resolution	0.001 ABS (0–1 ABS)
Wavelength Filters	420, 470, 520, 570, 620, & 660 nm
Wavelength Accuracy	$\pm 1$ nm
Wavelength Bandwidth	10 nm $\pm 1$ nm
Stray Light	< 1.0%

Instrument Rating	
Power Source	4 x AA 1.5V alkaline or lithium batteries, AC power adapter, or USB cable
Battery Life (w/o backlight)	4 months (typical use, 12 tests/day, 5 days/week) w/ low battery indicator
Max Current	100 mA @ 5VDC
AC Power Adapter Input	100-240 VAC, 50/60 Hz
Input and Output Connections	Mini-B female USB port for data transfer and connection to AC power adapter or USB cable
Environmental Conditions	Operational temperature range: 32°F–122°F (0°C–50°C) Up to 20000m Altitude

## Instrument Rating (cont'd)

Operational Humidity Limit	90% RH @ 122°F/50°C (non-condensing)
Dust and Water Ingress Protection	IP67-No ingress of dust; immersion in water of up to 1 meter for 30 minutes

## SYMBOL EXPLANATION

Symbol	Description
Voltage 	Indicates DC Voltage On instrument label
Action 	Indicates an action operation Appears on display
Information 	Indicates relevant information Appears on display
Error 	Indicates an operational error Appears on display
Warning (flashing) 	Indicates an operational warning Appears on display
USB 	Indicates data transfer mode Appears on display



# INSTRUMENT CERTIFICATION AND INFORMATION TO THE USER

The TTi<sup>®</sup> Colorimeter Series is certified to the following instrumentation Directives and Standards:

## Certification

- Directive 2004/108/EC, Electromagnetic Compatibility Directive
- Directive 2006/95/EC, Low Voltage Directive
- FCC, Radio Frequency Devices, Unintentional Radiators, 47 CFR Part 15, Subpart B
- UL 61010-1 - Safety Requirements for Electrical Equipment for Measurement, Control, and Laboratory Use - Part 1: General Requirements
- ICES-003 – Issue 4 February 2004 - Spectrum Management and Telecommunications Policy - Interference-Causing Equipment Standard - Digital Apparatus
- CSA C22.2 No. 61010-1 - Safety Requirements for Electrical Equipment for Measurement, Control, and Laboratory Use - Part 1: General Requirements
- EN 61326-1:2006 - Electrical Equipment for Measurement, Control and Laboratory Use - EMC Requirements - Part 1: General Requirements
- EN 61010-1:2001 - Safety Requirements for Electrical Equipment for Measurement, Control, and Laboratory Use - Part 1: General Requirements
- IEC 61010-1 - Safety Requirements for Electrical Equipment for Measurement, Control, and Laboratory Use - Part 1: General Requirements
- IEC 60947-1 - Pollution Degree 2. Normally, only non-conductive pollution occurs. Occasionally, however, a temporary conductivity caused by condensation may be expected.

## Information to the User

- The user is cautioned that if the instrument is used in a manner not specified by Taylor Water Technologies LLC, the protection provided by the instrument may be impaired.

- This device complies with Part 15 of the FCC Rules. Operation is subject to the following two conditions:
  - (1) This device may not cause harmful interference, and
  - (2) This device must accept any interference received, including interference that may cause undesired operation.
- The user is cautioned that changes or modifications not expressly approved by Taylor Water Technologies LLC, could void the user's authority to operate this equipment.
- NOTE: This equipment has been tested and found to comply with the limits for a Class B digital device, pursuant to Part 15 of the FCC Rules. These limits are designed to provide reasonable protection against harmful interference in a residential installation. This equipment generates, uses, and can radiate radio frequency energy and, if not installed and used in accordance with the instructions, may cause harmful interference to radio communications. However, there is no guarantee that interference will not occur in a particular installation. If this equipment does cause harmful interference to radio or television reception, which can be determined by turning the equipment off and on, the user is encouraged to try to correct the interference by one or more of the following measures:
  - Reorient or relocate the receiving antenna.
  - Increase the separation between the equipment and receiver.
  - Connect the equipment into an outlet on a circuit different from that to which the receiver is connected.
  - Consult the dealer or an experienced radio/TV technician for help.
- This Class B digital apparatus complies with Canadian ICES-003.
- Cet appareil numérique de la classe B est conforme à la norme NMB-003 du Canada.
- The CE mark indicates compliance with the following directives:
  - Directive 2004/108/EC, Electromagnetic Compatibility Directive
  - Directive 2006/95/EC, Low Voltage Directive

**NOTES**

---

---

---

---

---

---

---

---

---

---

---

---

---

---

---

---

---

---

---

---

---

---

---

---

---

---

---



*the most trusted name in water testing*

**A Fluidra Brand | [TaylorTechnologies.com](https://TaylorTechnologies.com) | 1.800.837.8548**

©2023 Taylor Water Technologies LLC. All rights reserved. Taylor® is a registered trademark of Taylor Water Technologies LLC, used under license. All other trademarks are the property of their respective owners.

**rev. 101223**

**Part #5543**